



**Duckworth & Kent Ltd.**  
titanium surgical instrument manufacturer

Femtosecond Laser, LASIK & LASEK Catalogue

## Instruments for Femtosecond Laser

DK Stein Utility Forceps



Gulani LASIK Marker



R J Mackool™ Femtosecond Laser Speculum



DK Femto Flap Lifter and Retreatment Spatula



Including LASIK & LASEK

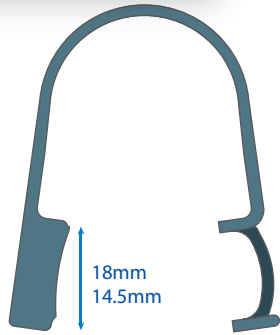

- Open blades, one open one solid
- Single piece construction
- Angled to rest temporally



Key features of the Bates LASIK Speculum: 1) Enables excellent exposure for LASIK or LASEK and allows, in particular, easy placement of the microkeratome. 2) Gives excellent retraction of the lower lid and of redundant lid tissue 3) Lower lid is protected from any inadvertent cuts from the microkeratome blade.

### Tutton Speculum, Open Blades

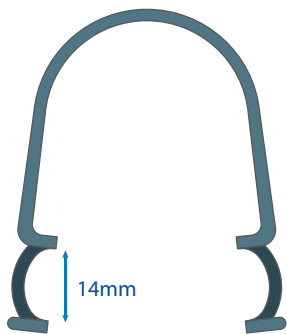

- Open blades
- Single piece construction
- Angled to rest temporally



### Markomanolakis Aspirating Speculum

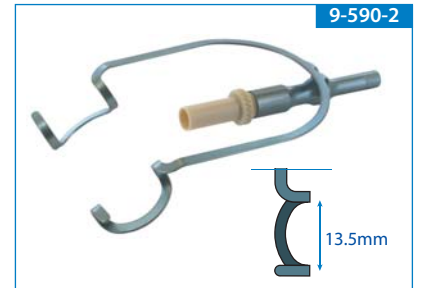

To accommodate different optimum positions for the aspirating port the length can be adjusted by rotating the knurled screw.

- Open blades
- Angled to rest temporally
- Adjustable aspirating port, can be increased in length by 4.0mm

### Williams Adjustable LASIK Specula

- Open blades
- Angled to rest temporally & nasally
- Adjustable with thumb screw

Designed to achieve maximum comfortable exposure of eye for suction ring placement to allow microkeratome to be easily positioned on the pivot post without obstruction during LASIK surgery. Lengthened speculum blades accommodate microkeratome. Simplicity and elegance of design allows speculum to be used in other types of ocular surgery.

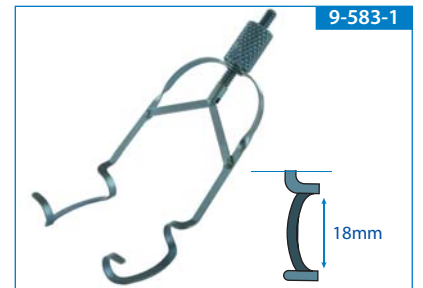
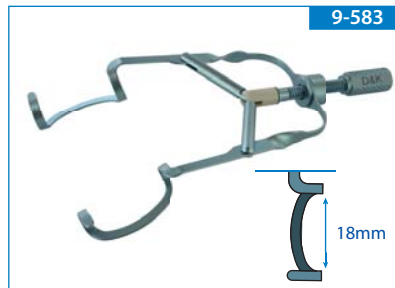

### Horn Adjustable Femtosecond Laser Speculum

- Open blades
- Angled to rest temporally
- Adjustable with thumb screw
- Suitable for Femtosecond Laser machine
- Can be used for manual cataract surgery and LASIK

The Horn Adjustable Femtosecond Laser Speculum has been designed with curved blades to allow clearance for docking devices, allowing exposure centrally without stretching the lids laterally, providing optimal exposure as well as patient comfort.

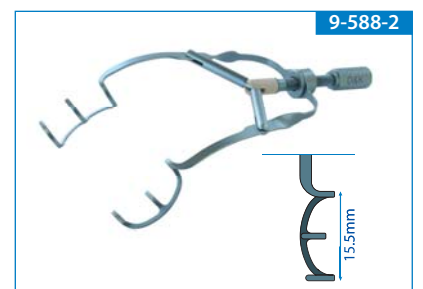

### Williams LASIK Speculum, Open Blades

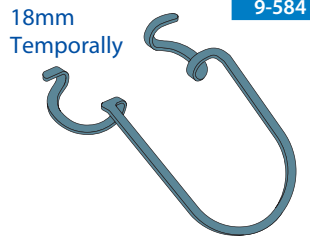
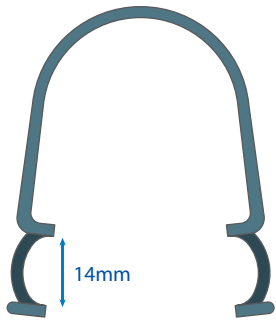

9-584

- Open blades
- Single piece construction
- Angled to rest temporally

### Buratto Adjustable Speculum

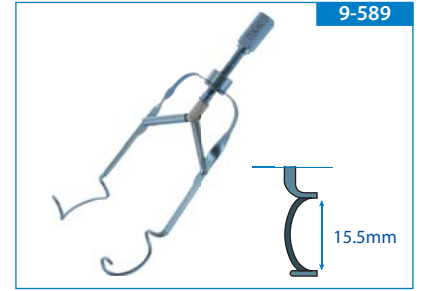

9-589

- Open blades
- Angled to rest temporally & nasally
- Adjustable with thumb screw
- Lightweight, compact and strong. Maximum exposure allows application of suction ring and microkeratome run.

### Buratto Adjustable Speculum

- Open blades
- Angled to rest temporally
- Adjustable with thumb screw
- Lightweight, compact and strong. Maximum exposure allows application of suction ring and microkeratome run.

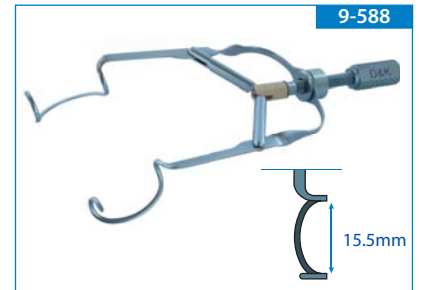

9-588

### R J Mackool™ Femtosecond Laser Speculum

9-588-1  
Maximum blade exposure allows application of suction ring when using the LenSx® Laser. LenSx® is registered to Alcon LenSx Inc.

- Open blades
- Angled to rest temporally
- Adjustable with thumb screw
- 9-588-1 Suitable for femtosecond laser machines

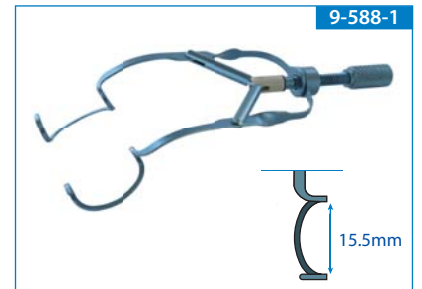

9-588-1

### Cionni Femto Speculum

- Ideal for surgeon performing anterior segment procedures from a temporal approach
- Nasal placement frees temporal aspect to provide total access to temporal limbus
- Self-locking mechanism ideal for topical anaesthesia since it prevents speculum from closing during procedure when patient blinks or squeezes, blades 15.5mm wide
- Open piece design, without telescoping or sliding arms, prevents speculum from "sticking or hanging up" after repeated use

New Temporal Speculum designed by Dr Cionni for the LenSx® Laser



9-585-1

Placed into palpebral fissure with locking mechanism situated nasally. Thumb plates are pressed together to open and capture lids. Crossing arms lock at four positions to accommodate various size palpebral fissures. Pressing thumb plates further releases locking mechanism, allowing surgeon easy removal of speculum. Releasable without opening to fullest extension, providing comfortable removal even in patients with small palpebral fissures.

## 9-850 Pallikaris LASIK Blade Marker



- Flat handle, length 106.0mm

Marks 10.0mm x 240° with central line from centre to 1.5mm beyond the diameter and line 90° to that line, 2.5mm below.

## 9-853 Bennett Thornton LASIK Marker

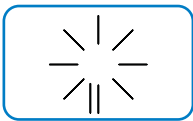

- Lowest profile with eight radial elements and non-radial element
- Round handle, length 126.5mm

Useful in realigning flap after repositioning following LASIK. Misalignment in any portion of flap can be readily seen since elements are at right angles to flap edges. The additional non radial element is useful in the event of a free flap. This position permits surgeon to properly orient flap and prevent flap from being laid upside down. Overall length of elements ensures flap edges will be included in the mark regardless of flap size. Open centre with pointer ensure simple and accurate marking on cornea, 45° angulation of head allows for ease and comfort in use.

## 9-854R LASIK Marker



- Lowest profile with three radial elements and two non-radial elements
- Round handle, length 98mm

## 9-855 Gulani LASIK Marker

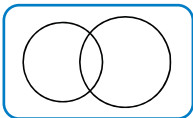

- 3.5mm and 4.0mm intersecting circles
- Round handle, length 119.0mm

Double circle marker (3.5mm and 4.0mm) provides pre-determined landmark (four reference points of two intersecting circles) for corneal flap replacement following excimer laser ablation of stromal bed in LASIK. Configuration of arcs of intersecting circles allows correct side-up placement of corneal flap.

## DK Epithelial Trephine with Trephine Guide and Alcohol Chamber

(order separately)



### DK Trephine Guide and Alcohol Chamber

- Alcohol chamber height 6.0mm
- Internal diameter 0.5mm larger than incision
- Round handle, length 125.0mm



### DK Epithelial Trephine

- Trephine creates a 300° incision into the epithelium
- Flat on knurled depicts the hinge of the epithelium flap
- Trephine height 20.0mm

Incision Size	DK Epithelial Trephine code	DK Trephine Guide & Alcohol Chamber code
Ø8.0mm	<b>6-924</b>	<b>6-944</b>
Ø8.5mm	<b>6-925</b>	<b>6-945</b>
Ø9.0mm	<b>6-926</b>	<b>6-946</b>
Ø9.5mm	<b>6-927</b>	<b>6-947</b>
Ø10.0mm	<b>6-928</b>	<b>6-948</b>
Ø10.5mm	<b>6-929</b>	<b>6-949</b>
Ø11.0mm	<b>6-930</b>	<b>6-950</b>

## Bates Trephine Guide and Alcohol Chamber with Fixation

(order separately)

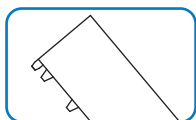

### Bates Trephine Guide and Alcohol Chamber with Fixation

- Low profile alcohol chamber, height 4.0mm
- Internal diameter 0.5mm larger than incision
- Designed as a guide for the DK Epithelial Trephine (see above)
- Round handle, length 125.0mm



### DK Epithelial Trephine

- Trephine creates a 300° incision into the epithelium
- Flat on knurled depicts the hinge of the epithelium flap
- Trephine height 20.0mm

Incision Size	DK Epithelial Trephine code	Bates Trephine Guide & Alcohol Chamber with Fixation code
Ø8.0mm	<b>6-924</b>	<b>6-944-1</b>
Ø8.5mm	<b>6-925</b>	<b>6-945-1</b>
Ø9.0mm	<b>6-926</b>	<b>6-946-1</b>
Ø9.5mm	<b>6-927</b>	<b>6-947-1</b>

# LASEK Instrument Set Guidance Notes

## Guidance notes only

### Example 1

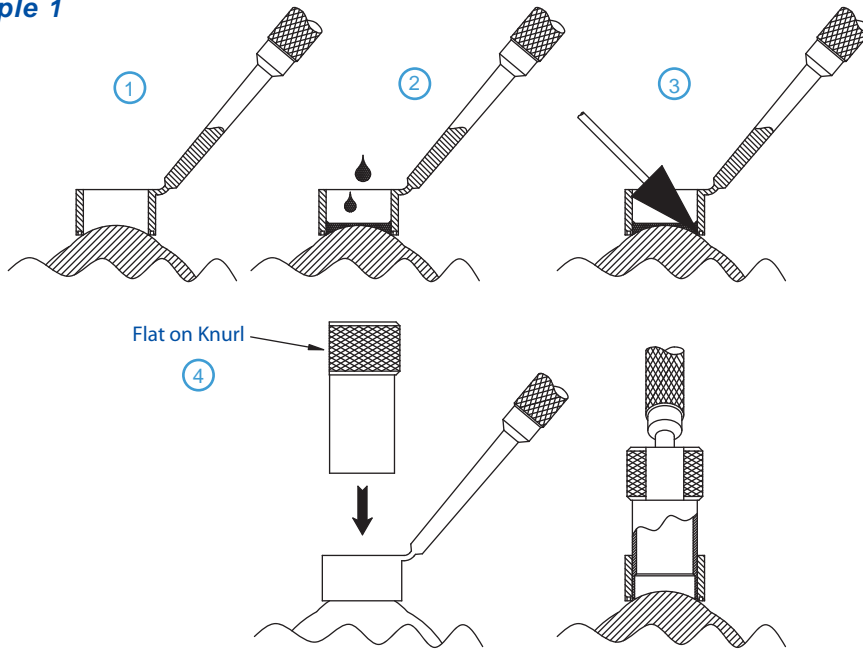

1. Centre alcohol chamber onto eye
2. Apply alcohol mixture into the chamber, covering the epithelium, and leave for the required time to soften the epithelium.
3. Soak up the excess alcohol.

4. Place the trephine into the alcohol chamber. The flat on the knurl of the trephine signifies the location of the hinge of the epithelium flap. Apply enough downward pressure with a slight twist in order to cut the tissue of the epithelium.

### Example 2

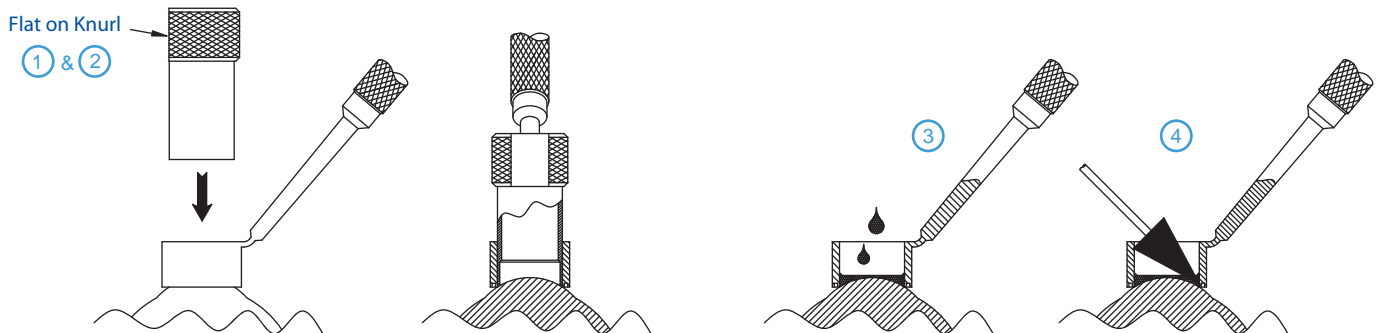

1. Centre alcohol chamber onto eye

2. Place the trephine into the alcohol chamber. The flat on the knurl of the trephine signifies the location of the hinge of the epithelium flap. Apply enough downward pressure with a slight twist in order to cut the tissue of the epithelium.

3. Apply alcohol mixture into the chamber, covering the epithelium, and leave for the required time to soften the epithelium.

4. Soak up the excess alcohol.

### Continuation after example 1 or 2

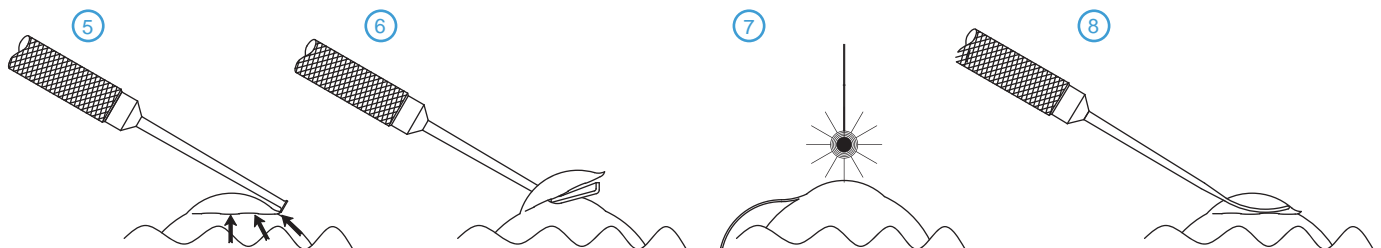

5. Remove the alcohol chamber, then using the 6-865 or 6-865-1, lift the edges around the incision of the epithelium flap.

6. Once the edges are raised, use the 6-866 (shown) or the 6-867 to separate and lift the epithelium.

7. Apply Laser.

8. Following the application of the laser, use the spatula (6-103-1) to replace and smooth the epithelium flap.

## 6-870 *Buratto LASIK Oval Spatula*

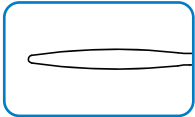

VIEW ON ARROW

- 1.3mm curved blade
- 35° angled curved shaft, tip to angle length 10.5mm
- Round handle, length 122.0mm



Designed to raise flap during LASIK.

## 6-870-1 *Buratto LASIK Oval Spatula*

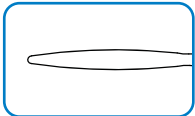

VIEW ON ARROW

- 1.3mm curved blade
- 60° angled curved shaft, tip to angle length 10.5mm
- Round handle, length 119.0mm



## 6-858 *Stevens Femto Flap Lifter*



VIEW ON ARROW

- Thin curved blade, 1.3mm wide with sharp edges
- 45° angled curved shaft, tip to angle length 10.5mm
- Round handle, length 122mm



## 6-859 *Stevens Femto Flap Lifter, narrow tip*



Narrow Tip

VIEW ON ARROW

- Thin curved blade with narrow pointed tip, 1.3mm wide, sharp edges
- 45° angled curved shaft, tip to angle length 10.5mm
- Round handle, length 122mm



The curved design of the Stevens Femto Flap Lifter glides smoothly to raise the flap, whilst the sharp edges are used to separate the adhesions under the flap that are left after the femtosecond laser.

## 6-606 *Ogawa Lamellar Dissector*

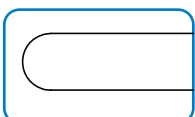

VIEW ON ARROW

- 2.5mm sharp edge tip
- 65° angled curved blade, tip to angle length 13.5mm



For use in lamellar corneal procedures. Sharp tip creates dissections with slightly rounded sides maintain single dissection plane. Curved blade minimizes distortion of cornea during dissection.

- Round handle, length 114.0mm

### 6-607 Morlet Lamellar Knife / Dissector

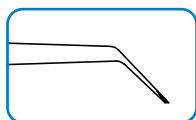
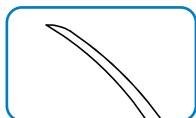

- 0.1mm x 1.5mm sharp edges
- 0.35mm x 2.0mm curved



- Angled shafts 12.0mm tip to curve, tip to angle length 3.0mm
- Round handle, length 110.0mm

### 6-608 DK Scleral Pocket Knife

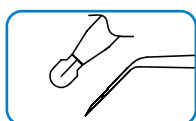

- 1.0mm x 1.0mm oval round blade, blade thickness 0.1mm
- 45° angled shaft, tip to angle length 3.0mm
- Round handle, length 118.0mm



### 6-609 Barrett Lamellar Dissector / Knife

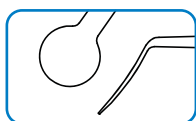

- Dissector
- 4.0mm round blunt edge
  - 55° angled shaft, tip to angle length 6.0mm

- Knife
- 2.0mm sharp rounded tip
  - 55° angled shaft, tip to angle length 6.0mm
  - Barrett balanced set handle, length 121.0mm



### 6-856-1 S.Antonio Spatula



- 0.5mm spatula
- Smooth shaft slightly curved shaft with tapered tip



- 45° angled shaft, tip to angle length 10mm
- Round handle, length 125mm

### 6-857 Stevens Femto Rim Lifter



- Sharp bullet shaped tip, 0.5mm long
- 45° angled shaft, tip to angle length 10.0mm



- Round handle, length 118mm
- The sharp tip of the Stevens Femto Rim Lifter is used after the femto second laser to sweep along the rim to delineate and open the flap.*



### 6-848 Krokchings Femto Incision Opening Spatula

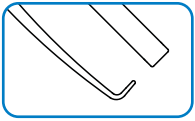
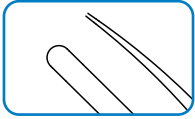

#### Femto Spatula (A)

- Fine flat tip, 0.5mm width
- 4mm slightly curved spatula blade
- Opens primary and secondary femto created incisions

#### Femto Spatula (B)

- 4mm slightly curved spatula blade
- Fine point, 0.5mm wide x 0.5mm 90° angled tip
- Opens limbal relaxing incisions (LRI)
- Round handle, length 119mm

### 6-850 Cionni Femto Spatula and Nucleus Divider

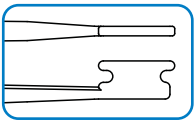
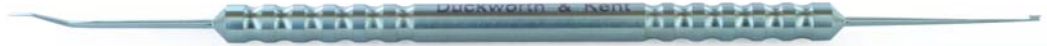
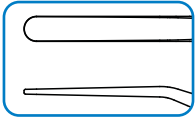

#### Femto Spatula

- Fine point, 0.5mm width
- 3mm spatula blade
- Opens primary and secondary femto created incisions

#### Nucleus Divider

- Blade 1.6mm x 0.8mm
- Used for pushing and pulling the iris or anterior capsule edge
- Round handle, length 131mm

### 6-855 DK Femto Flap Lifter and Retreatment Spatula



#### Flap lifter

- 0.4mm diameter, smooth polished surface
- Curved shaft, 12.0mm length

#### Retreatment Spatula

- 0.15mm tip diameter, rounded end
- Smooth polished surface
- Angle tip, length to angle 3.0mm
- Round handle, length 123mm

### 6-855-1 DK Femto Flap Lifter and Retreatment Spatula - Bullet Shaped Tip

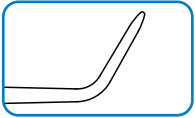

#### Flap lifter

- 0.4mm diameter, smooth polished surface
- Curved shaft, 12.0mm length

#### Retreatment Spatula

- 0.15mm tip diameter, bullet shaped tip
- Smooth polished surface
- Angle tip, length to angle 3.0mm
- Round handle, length 123mm

### 6-856 Femto Laser Spatula



- 0.5mm spatula
- Smooth shaft slightly curved shaft with blunt tip

- 45° angled shaft, tip to angle length 10mm
- Round handle, length 125mm

### 6-103-1 DK Double Ended Spatula (for repositioning epithelial flap)

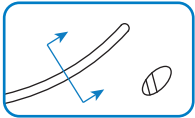
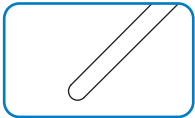

- 0.8mm diameter, double ended
- 45° angled shaft, tip to angle length 12.0mm, curved shaft

### 6-863 Tutton Double Ended Flat Oval Spatula / Elevator

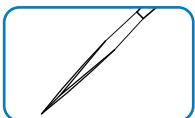

VIEW ON ARROW



- Flat broad oval spatula 5.44mm x 5.14mm x 3.15mm
- Elevator length from angle to tip 12.0mm
- Overall length 126.0mm

This double ended LASIK instrument consists of a spatula and an elevator. The elevator tip can be used to delineate the edge of a previous LASIK corneal flap, whilst the curved design glides smoothly over the stroma to raise the flap.

The flat broad oval spatula has a sharp edge which enables both the stromal base of the posterior surface of the flap to be debrided of any epithelial cells.

### 6-871 Buratto Double Flap Spatula

- 4.75mm hemi-disc spatula tips
- 30° angled curved shafts, tip to angle length 11.4mm
- Round handle, length 114.0mm

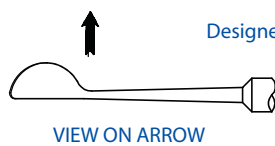

VIEW ON ARROW

Designed to protect stromal portion of flap close to hinge.

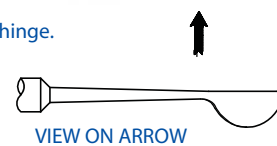

VIEW ON ARROW

### 6-876 Ogawa LASIK Spatula and Flap Protector

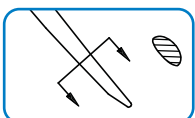
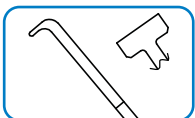

#### Flap protector

- 7.5mm x 3.0mm flattened tip
- 55° angled shaft, tip to angle length 4.0mm

#### Spatula

- 0.45mm x 0.8mm oval highly polished tip
- 55° angled shaft, tip to angle length 10.5mm
- Round handle, length 115.5mm

Two-in-one instrument decreases instrument tray clutter and keeps flap protector easily accessible. Spatula has tapered tip for ease of insertion under corneal flap. Polished surface on spatula minimizes friction, drag, and distortion of flap. Flap protector has a micro-lip on its tip to allow for additional retraction of flap when needed.

### 6-862 Gulani Neumann Hyperopic LASIK Flap Dissector

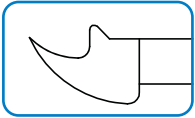

VIEW ON ARROW



VIEW ON ARROW



- Curved sharp edge, 3.0mm wide
- Round handle, length 86.0mm

Used to lift previous corneal flap in cases having undergone Hyperopic LASIK. Angled, curved base glides smoothly along stromal mound whilst top flat surface dissects plane of previous flap.

### 6-865 DK Epithelial Edge Lifter



- Hoe-shaped tip, 2.12mm - 0.6mm (width) x 1.85mm (height)
- Round handle, length 120.0mm

### 6-865-1 DK Angled Epithelial Edge Lifter

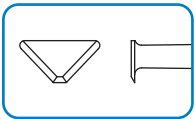

- Hoe-shaped tip, 3.52mm - 0.6mm (width) x 1.85mm (height)
- 45° angled shaft, tip to angle length 11.0mm
- Round handle, length 113.5mm

### 6-866 DK Epithelial Separator / Lifter

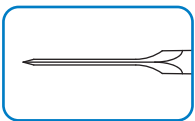

VIEW ON ARROW



- 3.0mm triangular-shaped tip
- 45° angled shaft
- Round handle, length 120mm

## 2-795 Stein Utility / Flap Lifting Forceps

## Forceps

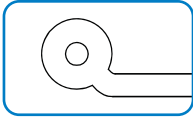

- Small flat ring tips
- 45° angled shafts, tip to angle length 3.5mm
- Standard handle, length 84.0mm

Designed with shortened, small flat ring tips for removal of contact lens at slit lamp biomicroscope. Useful contact lens removal following PRK and other refractive surgical procedures.



## 2-798 DK Stein Flap Lifting / Utility Forceps

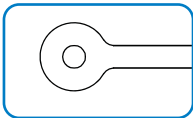

VIEW ON ARROW

- Small flat ring tips, inner tip surfaces lightly textured
- 25° angled shafts, tip to angle length 3.5mm
- Standard handle, length 85.0mm



Inner Tip Surfaces  
Are Textured

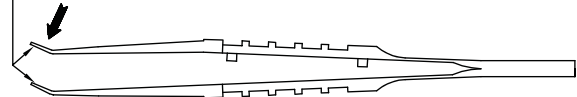

## 8-604 DK LASIK Cannula

## Cannulas



- 23 gauge
- 0.2mm diameter hole at tip
- Four 0.4mm diameter holes along side of shaft
- 25° Angled shaft, tip to angle length 8.0mm

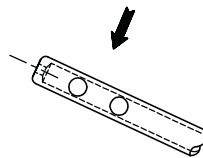

VIEW ON ARROW



For more and current information visit:  
[www.duckworth-and-kent.com](http://www.duckworth-and-kent.com)

[www.duckworth-and-kent.com](http://www.duckworth-and-kent.com)

7 Marquis Business Centre  
Royston Road, Baldock  
Herts SG7 6XL England

Tel: +44 (0)1462 893254  
Fax: +44 (0)1462 896288  
Email: [info@duckworth-and-kent.co.uk](mailto:info@duckworth-and-kent.co.uk)



© February 2012 Duckworth & Kent  
Revised 22.12.2014

D&K® is a registered trademark. All other brand names are trademarks or registered trademarks of their respective owners. All schematic line drawings, photographs and copy in this leaflet are fully protected by copyright. No part of this leaflet may be reproduced in any form without prior written permission. We reserve the right to make changes at any time, without notice, in product specifications and availability. Descriptive, typographic, or photographic errors are subject to correction. Name(s) of instruments are often comprised of surgeon's name, combination of surgeons' names or by the category of the instrument.

*at the Leading Edge*